



NOVINKY 2024

lucis.
interior lighting

BOWL



Typ: stropní a nástěnné svítidlo

Stínítko: bílé ručně foukané trojvrstvé sklo opál mat

Těleso svítidla: ocelový plech bíle lakovaný

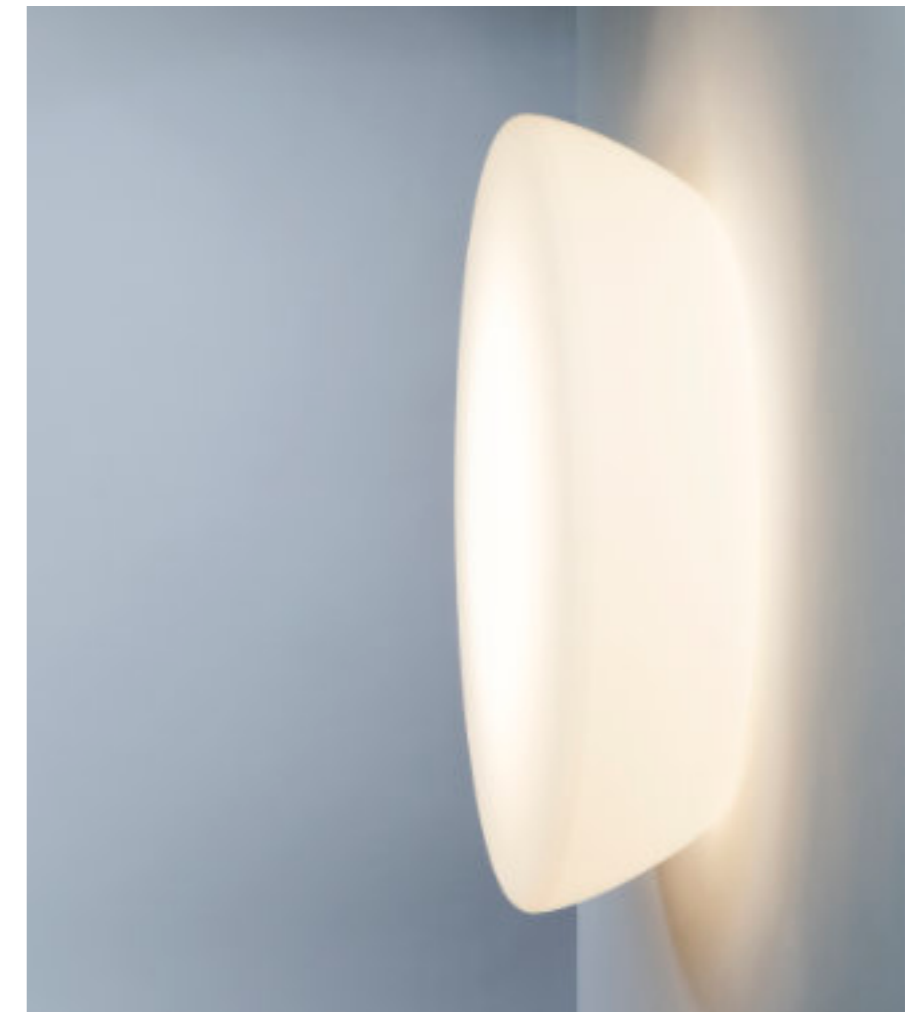
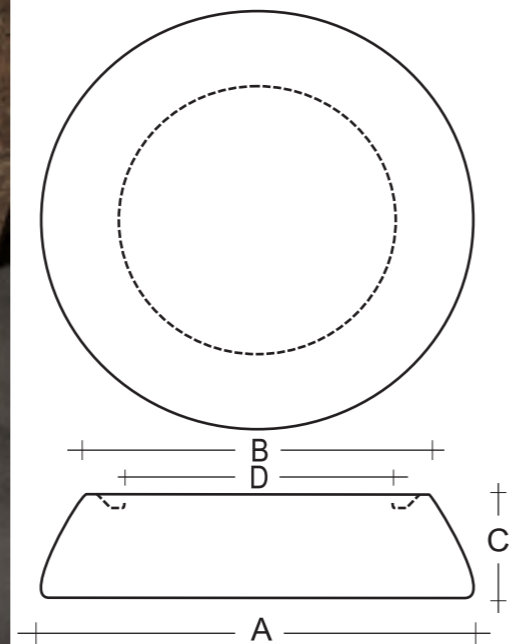

Typ	W	K	lm	A	B	C	D	DALI 2	☑	☑	☑	☑	☑	☑	☑
S0.K1.B45.Y	15,5	3000	2450/1856	450	350	110	285	M	-	-	Q*	-	-	4900	
S0.K2.B45.Y	15,5	4000	2506/1898	450	350	110	285	M	-	-	Q*	-	-	4900	
S0.K3.B45.Y	9,8	3000	1540/1169	450	350	110	285	M	-	-	Q*	-	-	4900	
S0.K4.B45.Y	9,8	4000	1575/1196	450	350	110	285	M	-	-	Q*	-	-	4900	
S0.K1.B50.Y	30,3	3000	4897/3714	505	407	110	332	M	O*	P*	Q*	-	-	7300	
S0.K2.B50.Y	30,3	4000	5009/3799	505	407	110	332	M	O*	P*	Q*	-	-	7300	
S0.K3.B50.Y	19,7	3000	3198/2426	505	407	110	332	M	O*	P*	Q*	-	-	7300	
S0.K4.B50.Y	19,7	4000	3271/2481	505	407	110	332	M	O*	P*	Q*	-	-	7300	

Y - ☑ ☑ ☑ ☑ ☑ (bez Y = standard, Y* = funkce dostupné na poptávku)

OMNIA GLASS

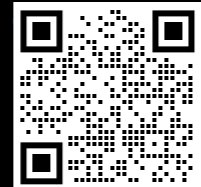

Typ: závěsné svítidlo

Stínítko: ručně foukané křišťálové sklo se zdrojem LED /direkt,indirekt/ umístěným v kovovém pouzdře a chráněným opálovými difuzory

Kovové části: ocelový plech lakovaný RAL Měď (.72), RAL Bronz (.73), RAL Mosaz (.74), RAL Zlato (.71)

Závěs: lankový s černým kabelem

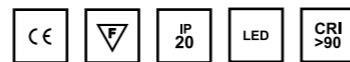
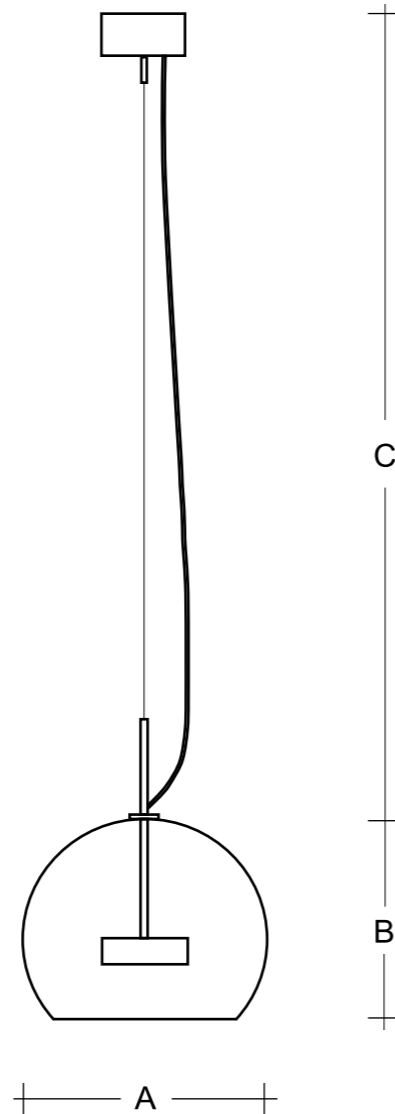

Typ	W	K	Im	A	B	C	DALI 2	☑	☑	☑	☑	☑	☑	☑
ZL1.K1.N25.XY	9,5	3000	1349/960	250	210	1790	M	-	-	Q*	R*	-	2400	
ZL1.K2.N25.XY	9,5	4000	1380/981	250	210	1790	M	-	-	Q*	R*	-	2400	
ZL1.K1.N35.XY	9,5	3000	1349/960	350	295	1705	M	-	-	Q*	R*	-	3200	
ZL1.K2.N35.XY	9,5	4000	1380/981	350	295	1705	M	-	-	Q*	R*	-	3200	

X - 71 ■ 72 ■ 73 ■ 74 ■

Y - M Q R (bez Y = standard, Y* = funkce dostupné na poptávku)



NUPAR GLASS

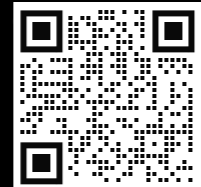

Typ: závěsné svítidlo

Stínítko: ručně foukané křišťálové sklo se zdrojem LED /direkt,indirekt/ umístěným v kovovém pouzdře a chráněným opálovými difuzory

Kovové části: ocelový plech lakovaný RAL 7016 (.62), RAL Měď (.72), RAL Bronz (.73), RAL Mosaz (.74), RAL Zlato (.71)

Závěs: tyčový

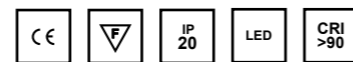
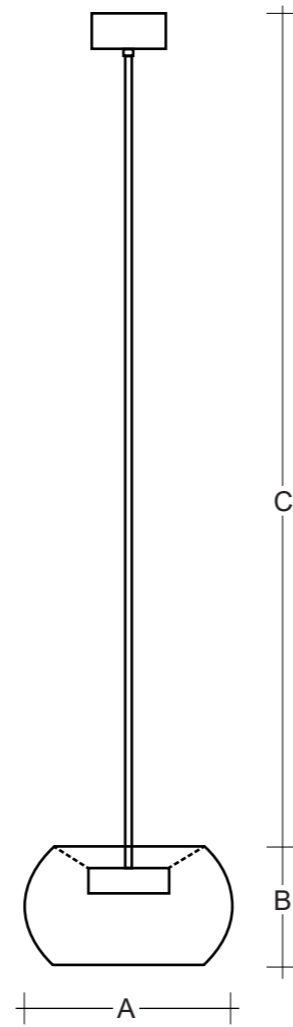

OMNIA ZT

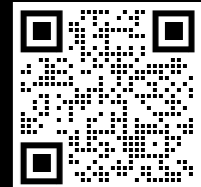

Typ: závěsné svítidlo

Stínítko: LED zdroj /direkt,indirekt/ umístěným v kovovém pouzdře a chráněným opálovými difuzory

Kovové části: ocelový plech lakovaný RAL 7016 (.62), RAL Měď (.72), RAL Bronz (.73), RAL Mosaz (.74), RAL Zlato (.71)

Závěs: tyčový

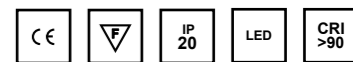

Typ	W	K	lm	A	B	C	DALI 2	☑	☑	☑	☑	☑	☑	☑
ZT.K1.NU3.XY	9,5	3000	1349/967	350	200	1430	M	-	-	Q*	R*	-	3500	
ZT.K2.NU3.XY	9,5	4000	1380/989	350	200	1430	M	-	-	Q*	R*	-	3500	

X - 62 ■, 71 ■, 72 ■, 73 ■, 74 ■
Y - M Q R (bez Y = standard, Y* = funkce dostupné na poptávku)

Typ	W	K	lm	A	B	C	DALI 2	☑	☑	☑	☑	☑	☑	☑
ZT.K1.02.XY	9,5	3000	1349/984	120	37	1500	M	-	-	Q*	R*	-	1500	
ZT.K2.02.XY	9,5	4000	1380/1006	120	37	1500	M	-	-	Q*	R*	-	1500	

X - 62 ■, 71 ■, 72 ■, 73 ■, 74 ■
Y - M Q R (bez Y = standard, Y* = funkce dostupné na poptávku)

Piktogramy



lištový systém - **R**



bluetooth ovládaní - **Q**



nouzový modul - **P**



pohybový senzor - **Q**



DALI 2 - **M**



zavěšení do sadrokartonu - **D**



výrobek odpovídá všem zákonným podmínkám a platným evropským normám



pro montáž na hořlavý podklad



svítidla pro základní prostředí



ochrana před vniknutím pevných těles větších jak 1 mm



CRI>90



svítidla se zdrojem LED



Tunable White



váha v g (uvedené hmotnosti jsou pouze orientační z důvodu ručního foukání skla-různé tloušťky)